

B-B Corte Vertical

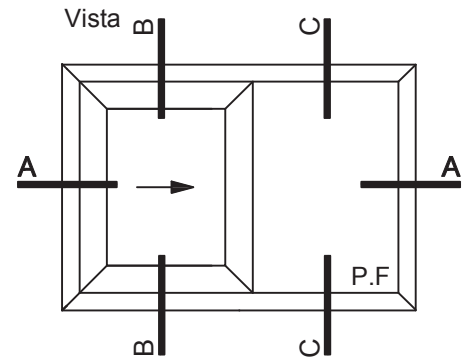

C-C Corte Vertical

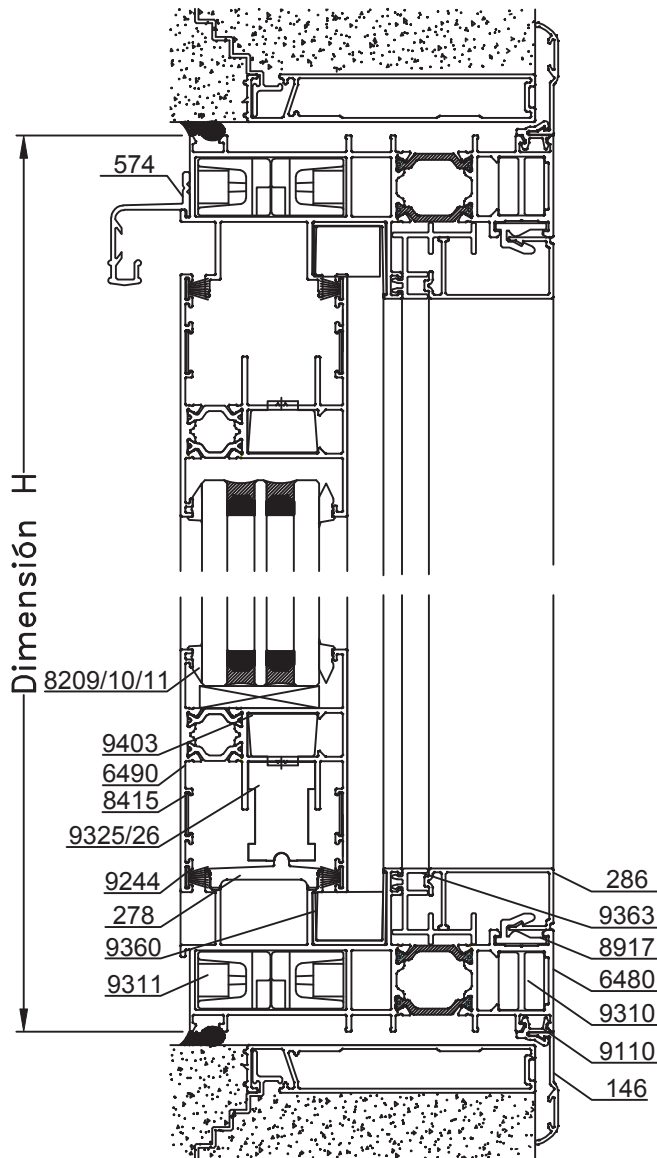

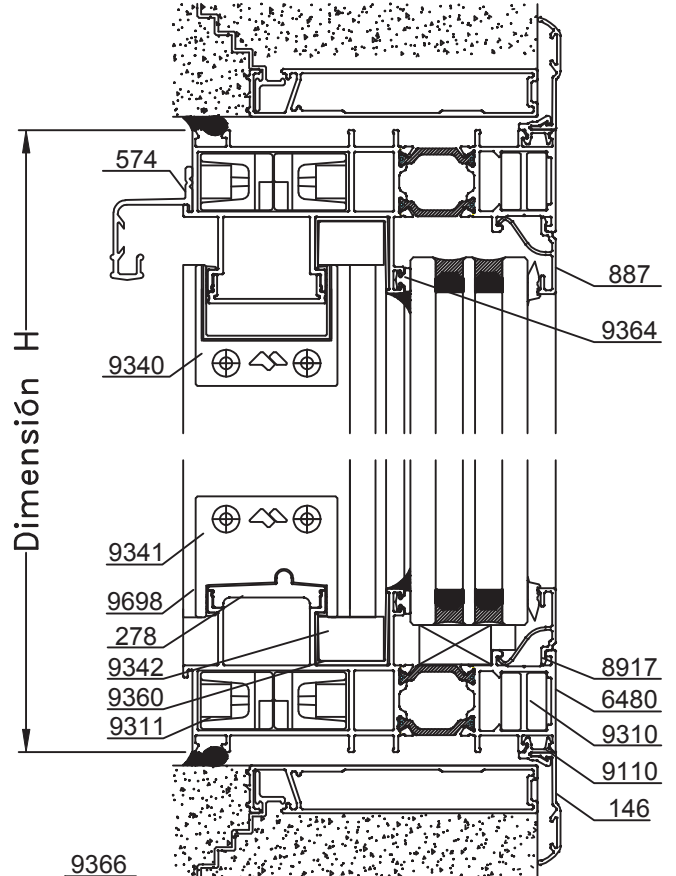

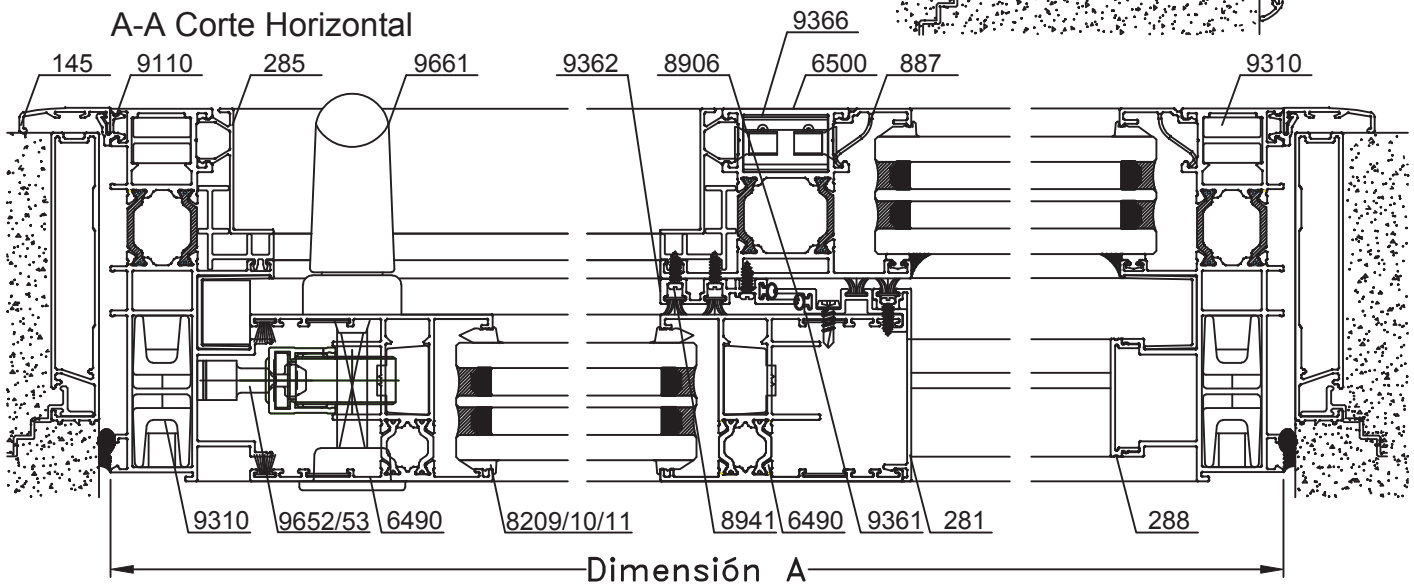





A-A Corte Horizontal



Escala 1:2.5









Tolerancia en Peso +/- 10%

05-04-18 **MEDITERRANEA-RPT.70**

Dimensiones de Corte				Ventana MF		
Código	Peso Kg/m	Forma	Función	Cant.	Largo	Corte
6480	2,30		Marco	2	A	45° 45°
				2	H	45° 45°
6490	1,61		Hoja	2	s/m	45° 45°
				2	H-92	45° 45°
6500	1,62		Travesaño	1	H-67	90°90°
278	0,49		Guía	1	s/m	90°90°
281	0,35		Cruce	1	s/m	90°90°
285	0,26		Tapa Vert.	2	s/m	90°90°
286	0,37		Tapa Horz.	2	s/m	90°90°
288	0,23		Tapa Horiz.	1	s/m	90°90°
			Tapa Vert.	1	s/m	90°90°
574	0,38		Goteron.	1	A	90°90°

- Dimensiones de Corte
Premarco y Accesorio
Premarco: pág. 29

* Medidas en milímetros

Detalle de Accesorios				De Rebatir
Ítem	Código	Descripción	Forma	Cantidad
Esc. de Armado	9310	Escuadra de Armado Marco	-	4 Unidades
	9311	Escuadra de Armado Marco	-	4 Unidades
	9403	Escuadra de Armado Hoja E-08		4 Unidades
	8415	Escuadra de Alineación E-62		8 Unidades
Clip	8917	Clip Contravidrio T-96		s/m
Burlete apoyo	9364	Burlete apoyo de 2 mm		s/m
	9365	Burlete apoyo de 3 mm		s/m
Cuña Vidrio	8209	Cuña Chica		2A + 2H
	8210	Cuña Mediana		
	8211	Cuña Grande		
Burlete Hermetic.	8906	Burlete AEL europeo		2H
Clip	9110	Clip Contramarco		s/m
Cierre	9652	Cierre de 3 puntos, 1200mm	-	1 Unidad
	9653	Cierre de 4 puntos, 1800mm		
Manijon	9661	Manijon con leva y cubeta	-	1 Unidad
Rodamiento	9325	Rueda Doble Reg. Pabose / M5 M-F	-	2 Unidades
	9326	Rueda Doble Reg. Pabose / M5 M-F Antic.		
Felpa	8942	Felpa de 7x6 (encuentro)		1 Unidad
	8244	Felpa de 7x8 con Fin Seal (Hoja)		
Fijación	9366	Fijación de perfil parante	-	2 Unidades
Tope Central	9340	Tope central (superior)	-	1 Unidad
	9341	Tope central (inferior)		
Cruce de Hoja	9342	Cruce de hoja	-	2 Unidades

s/m: según medida.

Tolerancia en Peso +/- 10%

05-04-18 **MEDITERRANEA-RPT.71**