

Paño Fijo para  
Colocación del Vidrio  
desde Interior o Exterior

B-B Corte Vertical

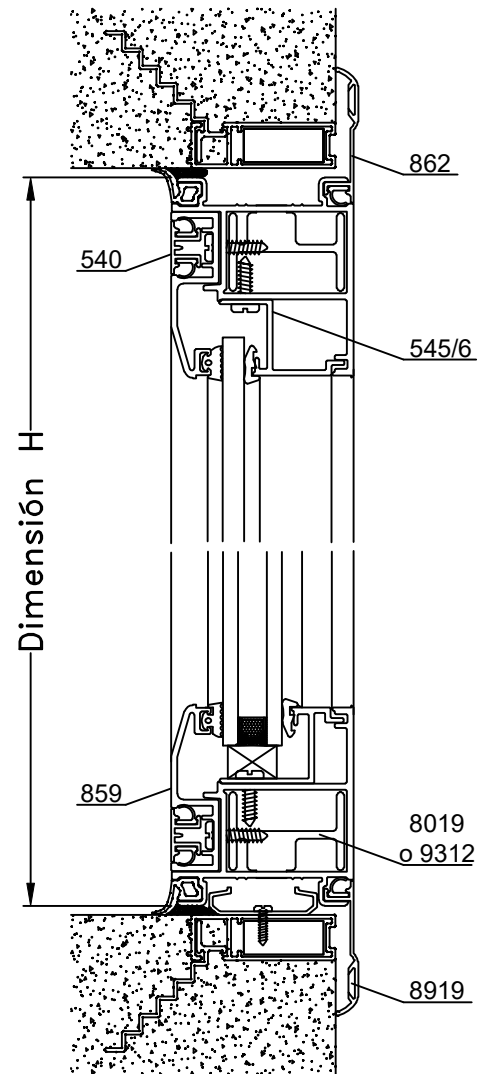

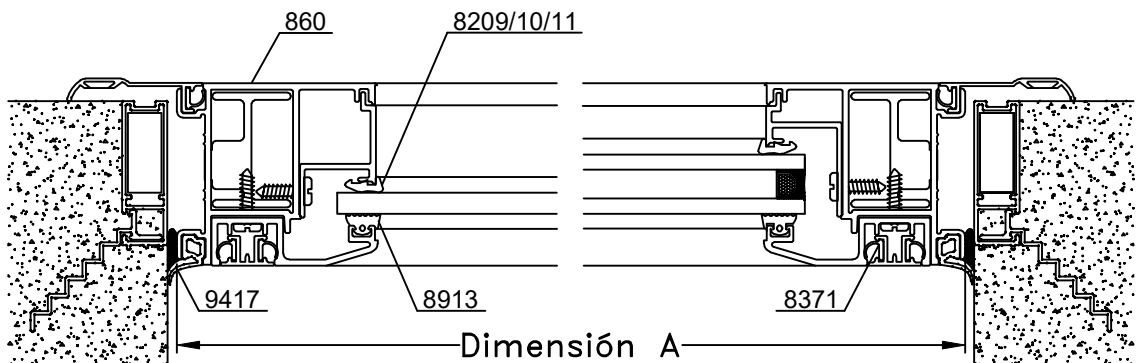

A-A Corte Horizontal







Escala 1:2.5

Tolerancia en Peso +/- 10%

12-12-16 **MEDITERRANEA.62**



Dimensiones de Corte						
Código	Peso Kg/m	Forma	Función	Cant.	Largo	Corte
860	1,19		Marco	2	A	45° 45°
				2	H	45° 45°
859	0,57		Soporte Vidrio	2	A-23	45° 45°
				2	H-23	45° 45°
540	0,15		Tapa Soporte	2	A-29	45° 45°
				2	H-29	45° 45°
545/546 611/612	-	-	Contra - Vidrio	2	A-81	45° 45°
				2	H-81	45° 45°

Código	Forma
545	
546	
611	
612	

Dimensiones de Corte Contramarco: pág. 27

\* Medidas en milímetros

Dimensiones de Corte Premarco: pág. 28

Detalle de Accesorios				
Ítem	Código	Descripción	Forma	Cantidad
Esc. de Armado	8019	Escuadra de Armado Descentrada E-22		4 Unidades
	9312	Escuadra de Expansión Descentrada E-22e		
Tornillo	-	Tornillo de Fijación Perfil Soporte		s/m
	-	Tornillo de Fijación Perfil Contravidrio		s/m
Clip	8371	Clip Mediterránea		s/m
Burlete Vidrio	8913	Burlete de Acristamiento B-68		2A + 2H
Cuña Vidrio	8209	Cuña Chica		2A + 2H
	8210	Cuña Mediana		
	8211	Cuña Grande		
Burlete Exterior	9417	Burlete Exterior Cubre Sello		2A + 2H

s/m: según medida

Accesorios Contramarco: pág. 27    Accesorios Premarco: pág. 28