

Vista

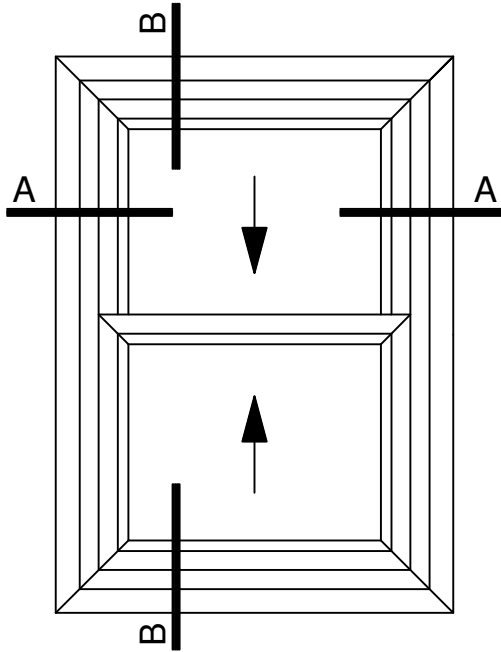

B-B Corte Vertical

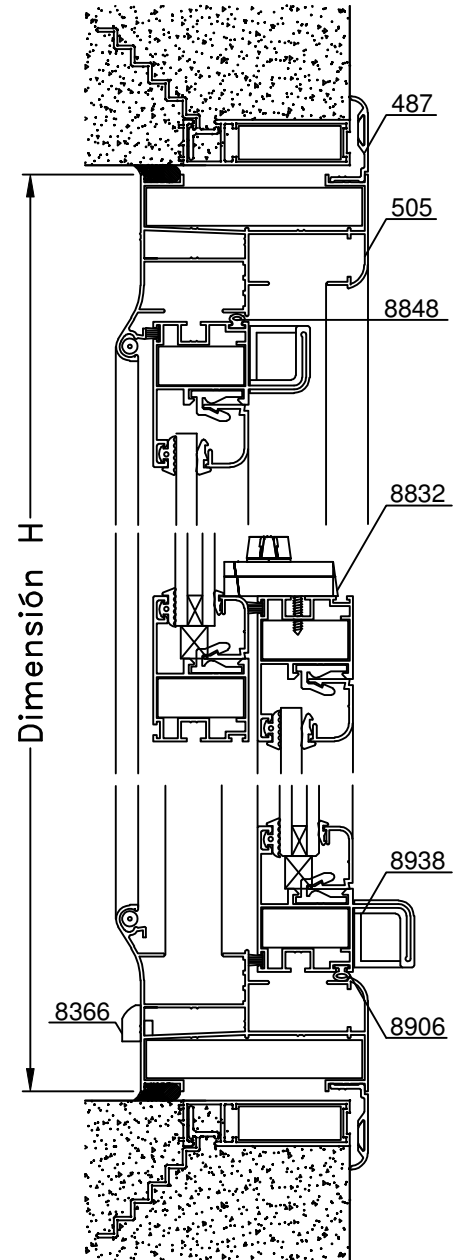

Nota:

Existe una alternativa de Cierre Central Coplanar (Cód. 8831), para las situaciones en las que no es posible utilizar el Cierre Convencional

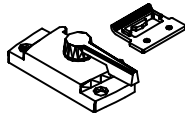



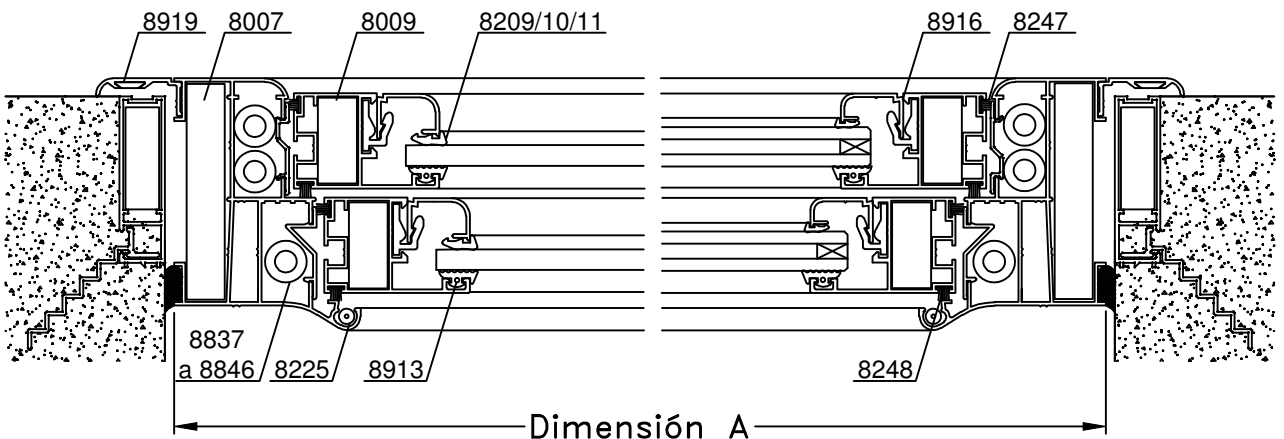

A-A Corte Horizontal



Escala 1:2.5

















Tolerancia en Peso +/- 10%

04-12-12 **GAMMA.38**

Dimensiones de Corte						
Código	Peso Kg/m	Forma	Función	Cant.	Largo	Corte
505	0,97		Marco	2	A	45° 45°
				2	H	45° 45°
506	0,69		Zócalo / Cabezal	1	A-81	45° 45°
				1	A-100	45° 45°
507	0,56		Hoja	1	A-81	45° 45°
				1	A-100	45° 45°
				4	H/2-22	45° 45°
508 (V.S.) 510 (D.V.H.)	-	-	Contra - Vidrio	2	A-136	45° 45°
				2	A-155	45° 45°
				4	H/2-77	45° 45°
509	0,14		Tapa	4	Alto del Comp.+20	90° 90°
487	0,17		Contra - Marco	2	A+52	45° 45°
				2	H+52	45° 45°

Dimensiones de Corte Premarco: pág. 11

* Medidas en milímetros

Detalle de Accesorios				
Ítem	Código	Descripción	Forma	Cantidad
Esc. de Armado	8007	Escuadra Parte "A" de 70.5 mm.		4 Unidades
	8009	Escuadra Hoja de Guillotina		8 Unidades
Clip	8916	Clip Contravidrios T-96		s/m
Tapón Lateral	8938	Tapón Lateral		4 Unidades
Burlete Vidrio	8913	Burlete de Acristalamiento B-68		4A + 2H
Cuña Vidrio	8209	Cuña Chica		4A + 2H
	8210	Cuña Mediana		
	8211	Cuña Grande		
Felpa	8247	Felpa de Polipropileno 5x5		2H
	8248	Felpa de Polipropileno 5x7		3A + 2H
Burlete Hermetic.	8848	Burlete de Hermeticidad GUA-162		1A
	8906	Burlete AEL europeo		1A
Cierre Central	8832	Cierre Central Guillotina		1 Unidad
	8831	Cierre Central Guillotina Coplanar		
Cierre Lateral	8833	Cierre Lateral Guillotina		2 Pares
Patín Lateral	8834	Patín Lateral		2 Pares
Barra Pivot	8835	Barra Pivot		2 Pares
Compensadores	8837 / 46	Compensadores H-118 (13'' a 31'')		2 Pares Ver pág. 40
Tapa Desagüe	8366	Tapa Desagüe T-69		2 Unidades
Tapón Hermetic.	8847	Tapón de Hermeticidad Caja de Agua		2 Unidades

s/m: según medida.

Accesorios Premarco: pág. 11