

Vista

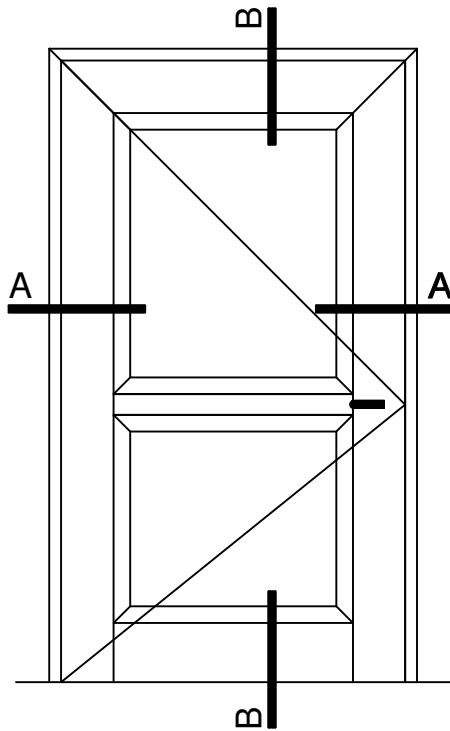

B-B Corte Vertical

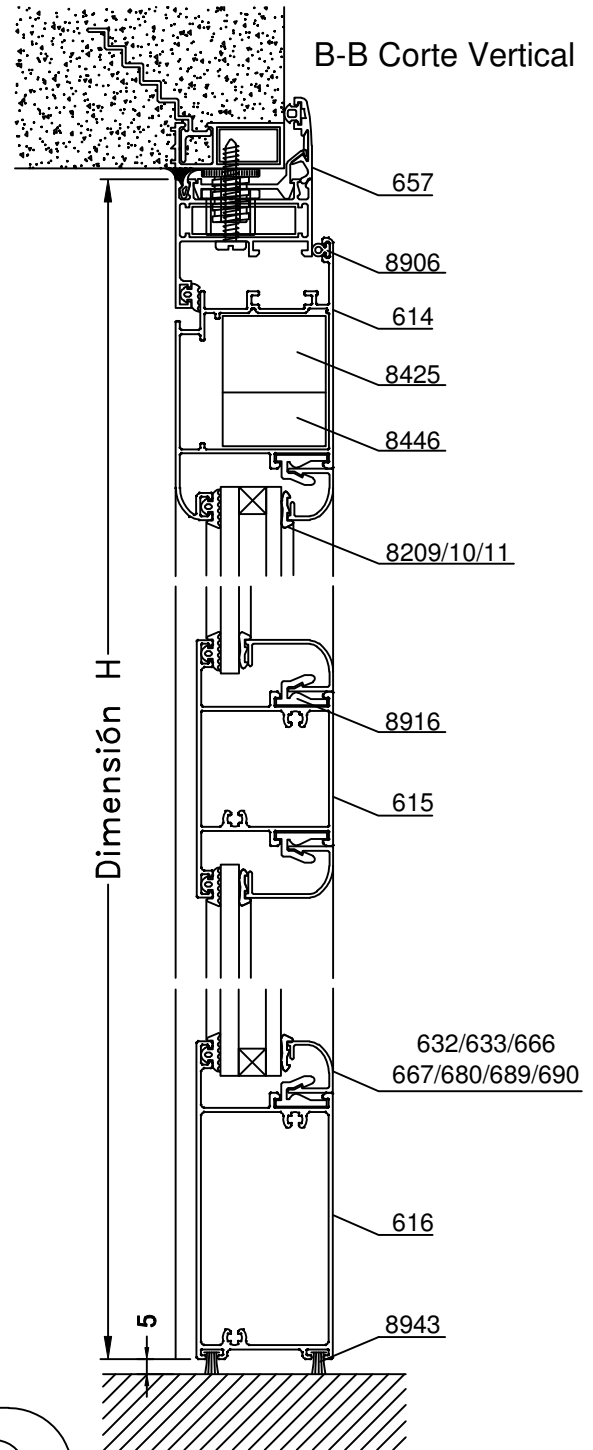

A-A Corte Horizontal

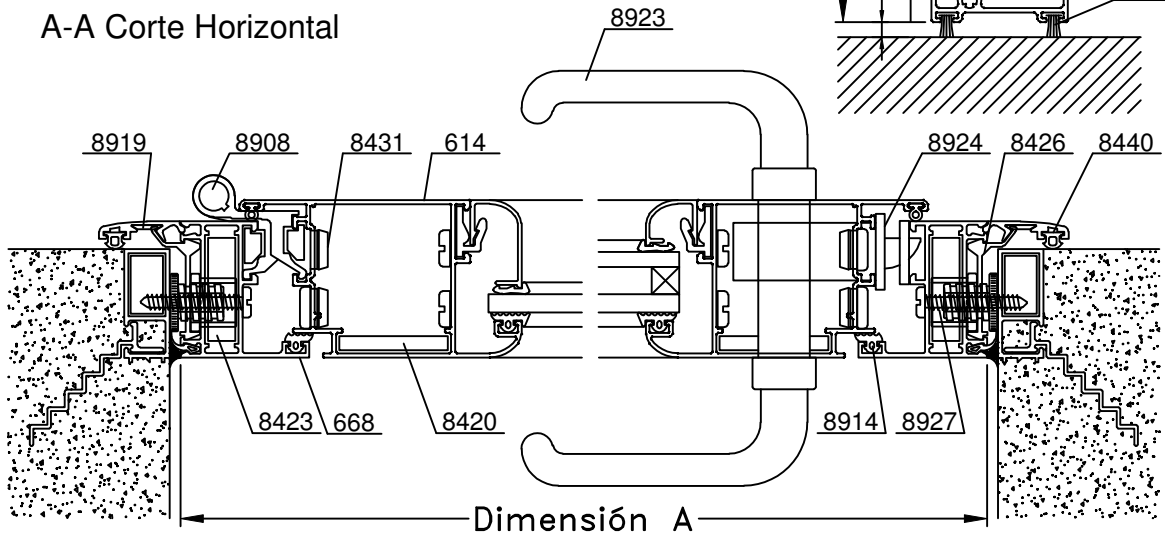

Escala 1:2.5















Tolerancia en Peso +/- 10%

25-07-15 **DELTA.37**

Dimensiones de Corte Puerta de Rebatir de 1 Hoja				Sin Travesaño			Con 1 Travesaño		
Función	Código	Peso Kg/m	Forma	Cant.	Largo	Corte	Cant.	Largo	Corte
Marco	668	0,66		1	A	45° 45°	1	A	45° 45°
				2	H	45° 90°	2	H	45° 90°
Parante	614	1,15		1	A-39	45° 45°	1	A-39	45° 45°
				2	H-25	45° 90°	2	H-24	45° 90°
Zócalo	616	1,29		1	A-192	90° 90°	1	A-192	90° 90°
Travesaño	615	1,09		-	-	-	1	A-192	90° 90°
Contravidrio Interior	Contravidrios Curvos	-	-	2	A-191	45° 45°	4	A-191	45° 45°
				2	H-223	45° 45°	4	H/2-142	45° 45°
	Contravidrios Rectos	-	-	2	A-191	90° 90°	4	A-191	90° 90°
				2	H-257	90° 90°	4	H/2-176	90° 90°

- Medidas en milímetros

- Dimensiones de Corte de Premarco y Contramarco, en página 5 5

Detalle de Accesorios Puerta de Rebatir de 1 Hoja			
Código	Descripción	Forma	Cantidad
8423	Escuadra de Armado E-69		2 Unidades
8425	Escuadra Parante E-70		2 Unidades
8446	Escuadra Suplementaria 40.5 mm. E-67		2 Unidades
8419	Tornillo Parker 12 x 1½ T-20		4 Unidades + 4U. x trav.
8431	Tapa Tornillo T-100		4 Unidades + 4U. x trav.
8916	Clip Contravidrio T-96		s/m
8913	Burlete de Acristalamiento B-68		2A + 2H + 2A x trav.
8209	Cuña Chica		2A + 2H + 2A x trav.
8210	Cuña Mediana		
8211	Cuña Grande		
8906	Burlete AEL Europeo		1A + 2H
8914	Burlete de Hermeticidad B-67		1A + 2H
8923	Manija Prima H-93		1 Unidad
8924	Cerradura H-51 (Kallay 5006)		1 Unidad
8920	Bisagra H-62 de 3 piezas con Kit		3 Unidades
8943	Felpa de 7x6 con Fin Seal		2A
8420	Porta Felpa T-99		2 Unidades

- Detalle de Accesorios para Fijación, Premarco y Contramarco en página 5 5

- s/m : según medida