

























CODIGO	PESO (Kg/m)	T. x P.	DESCRIPCION	FORMA	PAG
351	1,07	4	Media Columna Rotula Macho		5
352	1,23	3	Media Columna Rotula Hembra		5
359	0,75	5	Bota Agua Paño de Abrir p/ V.S		9
367	1,05	4	Columna Divisoria		3
368	1,78	2	Columna a 45°		4
369	0,38	10	Tapa de Columna		6
370	1,78	2	Columna a 90°		4
371	0,66	6	Tapa Columna a 90°		6
372	0,79	4	Tapa de Columna		6
373	0,78	4	Parante de Hoja p/V.S		9
374	0,68	5	Cabezal y Zócalo de Hoja p/V.S		9
376	0,60	7	Hoja DVH en Offset		7
377	0,69	5	Hoja c/Contravidrio V.S		9
378	0,79	4	Bota Agua Paño Fijo		9
761	0,64	6	Marco Perimetral		7
762	0,57	7	Cabezal y Zócalo de Hoja para Vidrio Estructural		7
763	0,68	4	Bota Agua Paño Fijo para Vidrio Estructural		7
764	0,60	4	Bota Agua Paño de Abrir para Vidrio Estructural		7
765	1,31	2	Columna de 57 mm		3
766	0,56	8	Parante de Hoja para Vidrio Estructural		7
767	1,82	2	Columna de 97 mm		3
768	1,07	4	Media Columna de 97 mm		4
769	0,63	6	Hoja D.V.H. Pegado para Vidrio Estructural		7
770	0,83	4	Hoja D.V.H. con Contravidrio		8

Tolerancia en Peso +/- 10%

 T. x P.: Tiras por Paquete
 07-01-13 **FRENTE VIDRIADO.2**

CODIGO	PESO (Kg/m)	T. x P.	DESCRIPCION	FORMA	PAG
771	0,15	15	Contravidrio		8
781	0,85	2	Bota Agua Paño de abrir		8
782	0,81	4	Bota Agua Paño fijo		8
798	2,79	1	Columna Grande (151 mm)		5

T. x P.: Tiras por Paquete

Inercias de los perfiles

	PERFIL	$I_{xx}' (mm^4)$	$I_{yy}' (mm^4)$
	351	362800	85100
	352	355600	165200
	765	139809	209066
	767	623695	423913
	798	2636986	808682

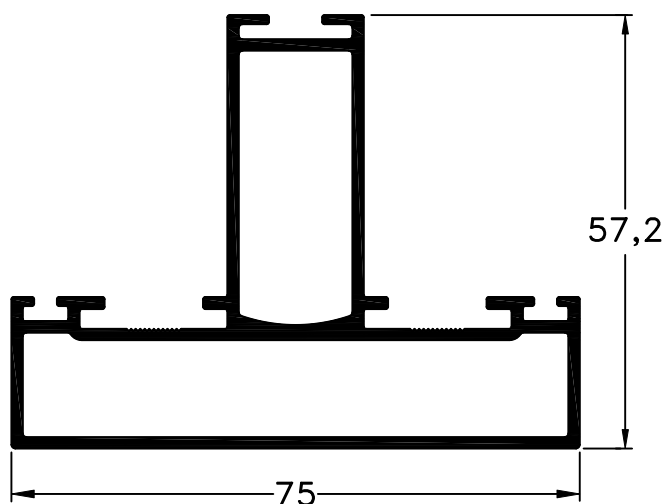

765 - Columna de 57 mm
peso: 1,31 Kg/m

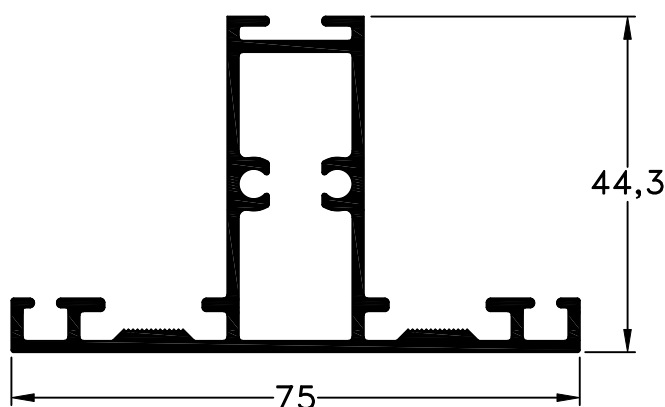

367 - Columna Divisoria
peso: 1,05 Kg/m

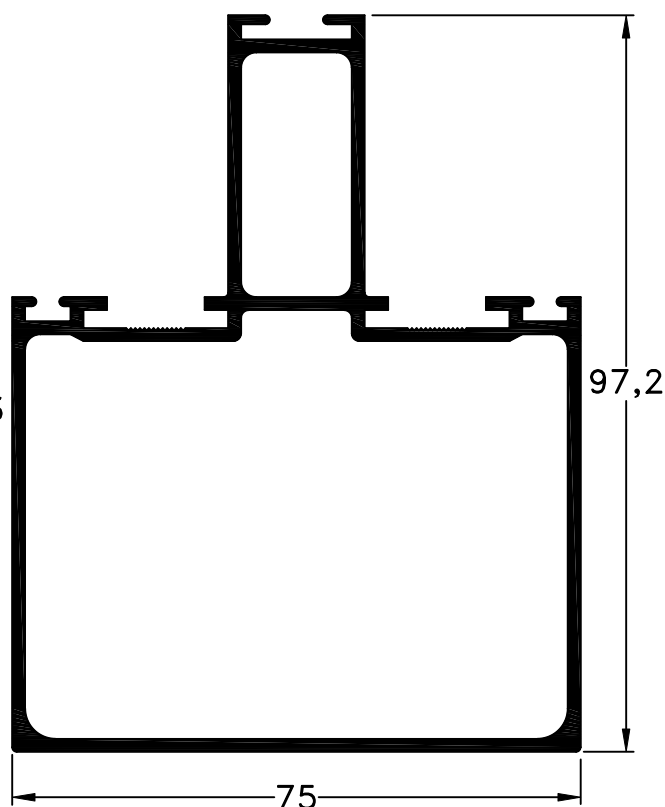

767 - Columna de 97 mm
peso: 1,82 Kg/m

Escala 1:1

Tolerancia en Peso +/- 10%

 07-01-13 **FRENTE VIDRIADO.3**